

Date	<input type="text"/>	Type	<input type="text"/>
Specifier	<input type="text"/>	Project Name	<input type="text"/>



MICRO EMA 04

Design: QUATTROBI TECHNICAL DEPARTMENT

Led track light projector with magnetic fastening system.

Listings: US LISTED



M4004

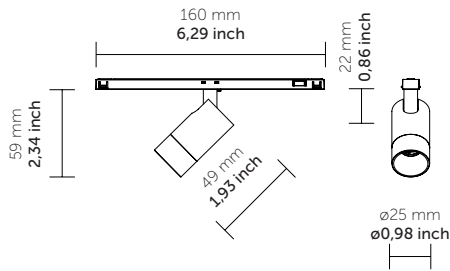

Only for track 9600 Series (rectilinear)

PRODUCT FEATURES

Type:	Track
Applications:	Indoor
Luminaire material:	Aluminium alloys
Protective screen:	Polycarbonate
Light source:	LED
Power Supply:	DC/DC led driver integrated
Wattage:	3
Delivered lumens:	2x180 lm
Color Temp:	3000K, 4000K
CRI:	80+
Dimming:	Dali

Specification recap

Type	Item #	Quantity

*Please make sure to include fixture and any accessories.

MICRO EMA 04

Design: QUATTROBI TECHNICAL DEPARTMENT



Ordering info

Model	Adapter	Cri/Color	Beam	Dimming	Finish
-----	-	----	-		--
M4004 (1x3W)	P Serie 9600 compatible	8030 80CRI/3000K 9030 90CRI/3000K 8040 80CRI/4000K 9040 90CRI/4000K	S Spot M Medium E Elliptical Other on request	D Dali	01 white 02 black Other on request

Ordering example :**M4004 P 8030 M 01**

(*) adapter for Micro Track 9600 series, installable only in class 2 circuit
Long arm version for St2, St5, St10, St14 Multisystem Evo 9500 track, on request
(°) not available for P version Serie Micro 9600

MICRO EMA 04

Design: QUATTROBI TECHNICAL DEPARTMENT



Multiplying factors: (Multiplying Factor is based on 80CRI/3000K)

CCT	80CRI/3000K	80CRI/3500K	80CRI/4000K	90CRI/3000K
Factor	1.0	1,035	1,053	0,847

Wattage	3W
Factor	1.0

Photometry

8030 S 3W 3000K

Lumens: 180

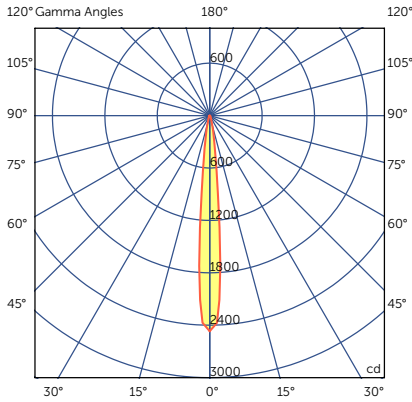

Candelas at Nadir

Deg	Candela
0	2467.72
5	894.83
15	88.28
25	27.55
35	12.52
45	8.14

8030 M 3W 3000K

Lumens: 180

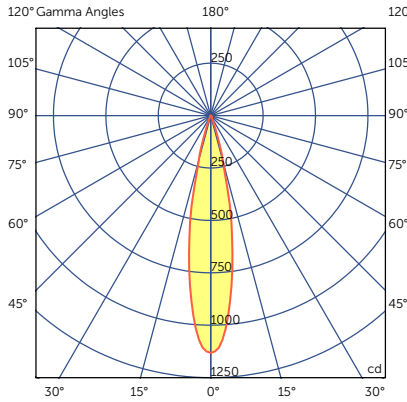

Candelas at Nadir

Deg	Candela
0	1131.24
5	886.25
15	190.97
25	13.99
35	5.04
45	4.56

8030 EL 2x3W 3000K

Lumens: 180

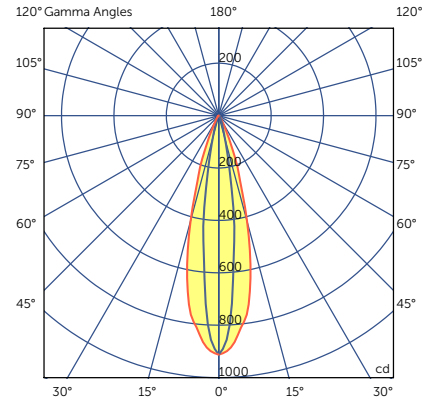

Candelas at Nadir

Deg	Candela
0	912.01
5	813.10
15	362.38
25	63.00
35	14.96
45	7.02

Date	<input type="text"/>	Type	<input type="text"/>
Specifier	<input type="text"/>	Project Name	<input type="text"/>



EMA TRACK

Led track light projector with magnetic fastening system.

PRODUCT FEATURES

Installation	Suspended / Surface / Recessed
Track housing	Extruded aluminum
Finishing	White, Black

ST1: Surface

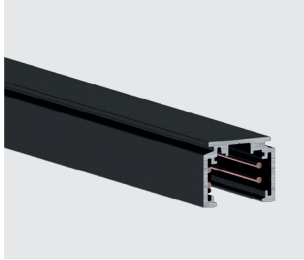

ST1 Curved: Surface



ST2: Suspended

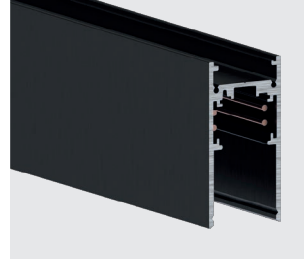

ST3: Recessed

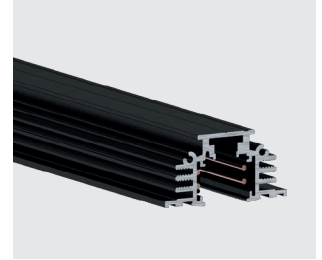

ST5: Recessed



ST6: Suspended

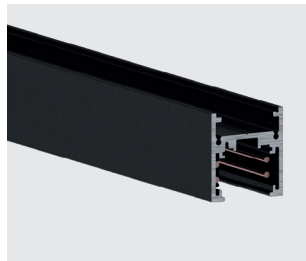

ST7: Suspended

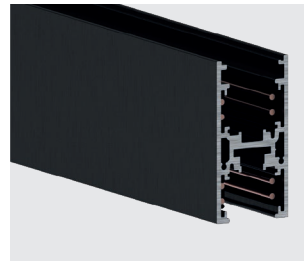

ST8: Recessed



ST9: Suspended

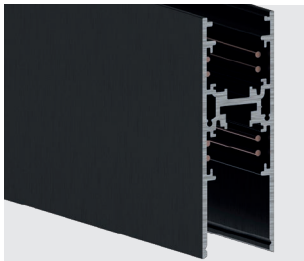

ST10: Recessed



ST13: Recessed

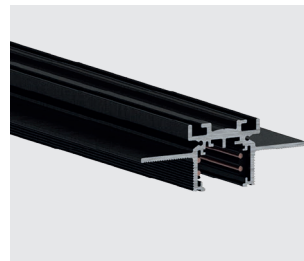

ST15 Round: Surface



ST18: Recessed

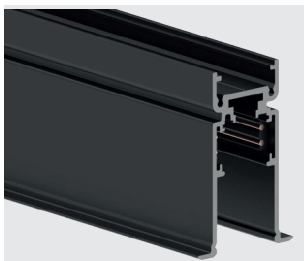

Ordering info

Model	Length	Finish	Version
----		--	----
A9500	-1/ 39,37" (1 mt.) -2/ 78,74" (2 mt.) -3/ 118,1" (3mt.)	B black W white	-ST1 -ST2 -ST3 (black color only) -ST5 (black color only) -ST6 -ST7 -ST8 -ST9 -ST13 -ST15 -ST18
	-4' / 1219,2 mm -8' / 2438,4 mm in request		

For dry location Class2

(*) Track Multisystem 9500 series

Quattrobi Inc. 2003 NW Royal Fern CT, Palm City, FL 34990 +1.347.613.5772 info@quattrobi.net

Due to the dynamic nature of lighting products and the associated technologies, luminaire data on this sheet is subject to change at the discretion of Quattrobi Inc.

© copyright Quattrobi Inc 2024

ST1: Surface

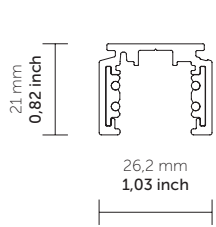

ST2: Suspended

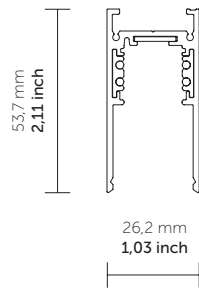

ST3: Recessed

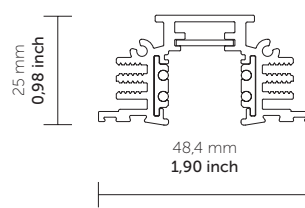

ST5: Recessed

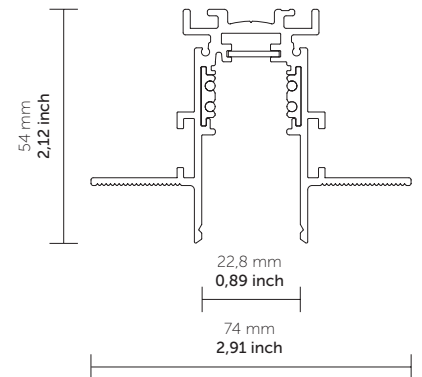

ST6: Suspended

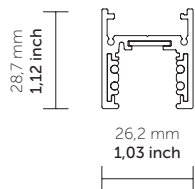

ST7: Suspended

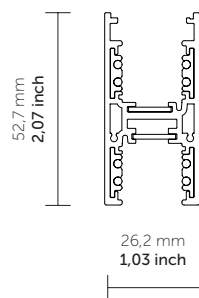

ST8: Recessed

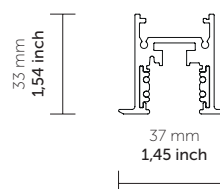

ST9: Suspended

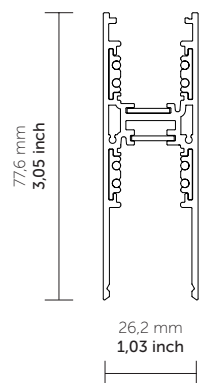

ST10: Recessed

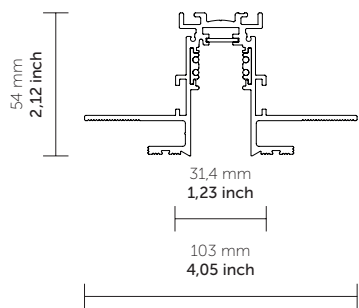

ST13: Recessed

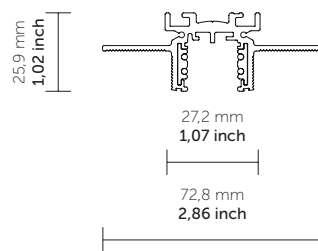

ST15 Round: Surface

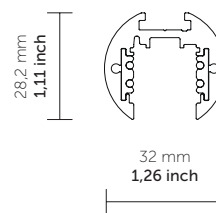

ST18: Recessed

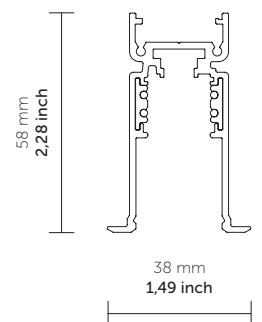

All power supplies:

M 040 48 12 - 40 Watt

M 080 48 12 - 80 Watt

M 150 48 12 - 150 Watt

M 185 48 12 - 185 Watt

M 320 48 12 - 320 Watt

Remote Driver, input voltage 120V 60Hz , output class2 48V DC 2Amps

Accessories

For Track: **ST1 - ST2 - ST3 - ST5 - ST6 - ST7 - ST8 - ST9 - ST10 - ST13 - ST15 - ST18**
 Available colours: **W** - white RAL 9010, **W2** - white RAL 9016, **B** - black RAL 9005

Painted metal body end caps

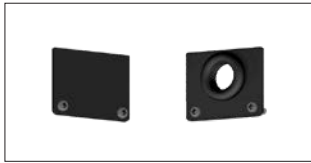

9504/ST1-...

Polycarbonate body end caps

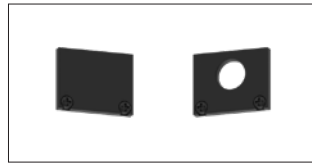

9504/ST1-P-...

Painted metal body end caps

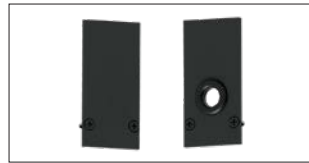

9504/ST2-...

Polycarbonate body end caps

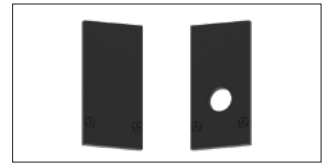

9504/ST2-P-...

Painted metal body end cap



9504/ST3...

Template for 9500...ST5... Track



S-9500/D1-ST5

Painted metal body end caps

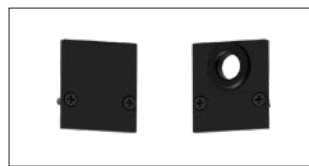

9504/ST6-...

Polycarbonate body end caps

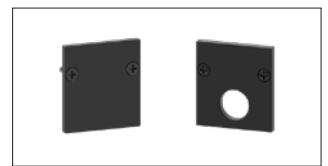

9504/ST6-P-...

Painted metal body end cap

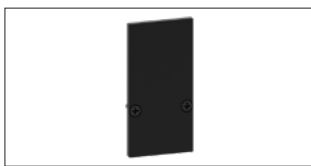

9504/ST7-...

Painted metal body end cap



9504/ST8-...

Painted metal body end cap

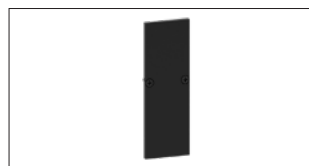

9504/ST9-...

Template for 9500...ST10... Track

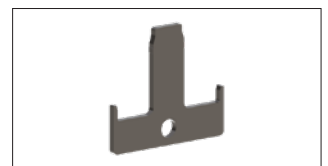

S-9500/D1-ST10

Template for 9500...ST13... Track



S-9500/D1-ST13

Polycarbonate body end cap



9504/ST15-P-...

Painted metal body end caps

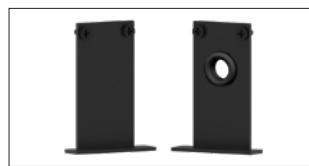

9504/ST18-...

Aesthetic track cover

For: ST1, ST3, ST6, ST7, ST8, ST13

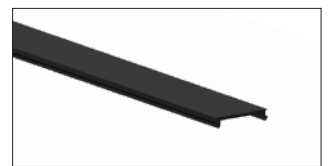

S-9500/SE-... (L: 3m)

Opal screen

For: ST1, ST3, ST6, ST7, ST8, ST13

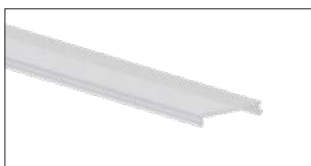

S-9500/SE-OPN-3000 (L: 3m)

Fumè screen

For: ST1, ST3, ST6, ST7, ST8, ST13



S-9500/SE-F-3000 (L: 3m)

Microprismatic screen TL=87%

For ST2, ST6

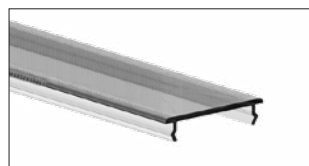

S-9500/MIC-3000 (L: 3m)

Opal screen TL=56%

For ST2, ST6



S-9500/SE-... (L: 3m)

Accessories

For Track: **ST1 - ST2 - ST3 - ST5 - ST6 - ST7 - ST8 - ST9 - ST10 - ST13 - ST15 - ST18**
Available colours: **W** - white RAL 9010, **W2** - white RAL 9016, **B** - black RAL 9005

Transparent screen TL=90%

For ST2, ST6



S-9500/TR-3000 (L: 3m)

Aesthetic track cover

For:ST2, ST5, ST9



S-9500/LE-... (L: 3m)

Plaster installation guard

For: ST5

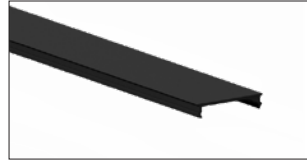

S-9500-L/B-... (L: 3m)

Opal screen

For: ST1, ST3, ST6, ST7, ST8, ST13

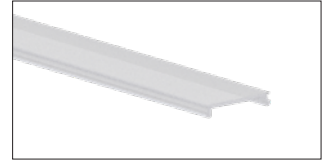

S-9500/SE-OPN-3000 (L: 3m)

Cutting tool for track
conductors

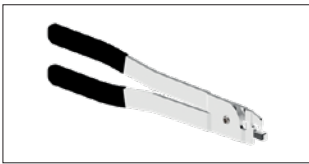

S-9000/T

Polarized connections



For Track: **ST1 - ST2 - ST3 - ST5 - ST6 - ST7 - ST8 - ST9 - ST10 - ST13 - ST15 - ST18**

Available colours: **W** - white RAL 9010, **B** - black RAL 9005

Polycarbonate body end-feed-left

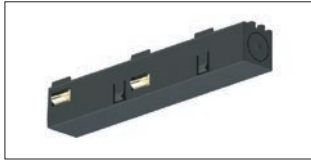

9501-S-KL/...-E

Polycarbonate body end-feed-right

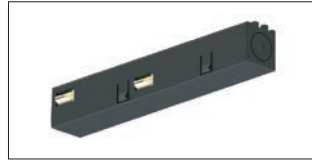

9501-S-KR/...-E

Polycarbonate body jointing connector

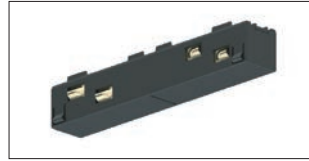

9503-S-K/...-E

Polycarbonate body mechanical jointing connector

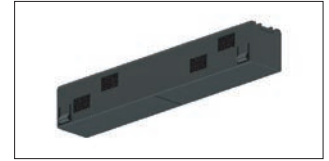

9503-S/...-M-E

Polycarbonate body internal polarized L feed



9511-KI/...-E

Polycarbonate body external polarized L feed



9511-KE/...-E

Polycarbonate body polarized T-feed



9513-K/...-E

Polycarbonate body polarized T-feed



9514-K/...-E

Polycarbonate body polarized T-feed



9515-K/...-E

Polycarbonate body polarized T-feed

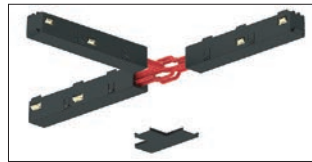

9516-K/...-E

Polycarbonate body polarized X-feed



9517-K/...-E

Polycarbonate body adjustable corner

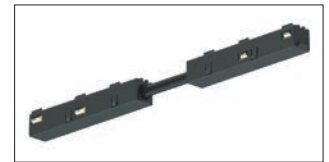

9518-S-K/...-E

Track fixing accessories

For Track: **ST1 - ST2 - ST3 - ST5 - ST6 - ST7 - ST8 - ST9 - ST10 - ST13 - ST15 - ST18**
 Available colours: **W** - white RAL 9010, **W2** - white RAL 9016, **B** - black RAL 9005

Complete suspension kit

For: ST2, ST6, ST8



9500-KIT1-1,5
9500-KIT1-3
9500-KIT1-5

Complete suspension kit

For: ST2, ST6, ST8



9500-KIT2-1,5
9500-KIT2-3
9500-KIT2-5

Suspension set

For: ST2, ST6, ST7, ST9, ST15



S-9000-P6-P-...

Set for ceiling mounting with cup and terminal block

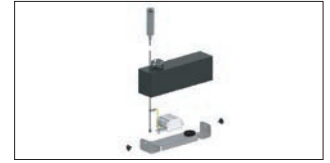

SET-RS/...-3

Set for ceiling mounting with cup and terminal block



SET-RS/...

Suspension set

For: ST2, ST6, ST7, ST9, ST15



S-9000-P3-...

Set for ceiling mounting with cup and terminal block

For: ST2, ST6, ST7, ST9, ST15



S-9000-P5-...

Suspension set

For: ST2, ST6, ST7, ST8, ST9, ST15



S-9000-P6-S-...

Suspension set

For: ST5, ST8, ST10



S-9000-P4

Ceiling clamp

For: ST2, ST6



S-9500/114-...

Track fast fixing clamp with gripper

For: ST2, ST6, ST7, ST8, ST9



S-9500/114-T-...

Track fast fixing clamp

For: ST2, ST6, ST7, ST8, ST9



S-9500/115-...

Clamp with m6 gripper

For: ST5, ST10, ST13



S-9000-P2/117

Fast fixing clamp with m6 threaded gripper

For: ST5, ST10, ST13



S-9000/118-...

Recessed clamp

For: ST8



S-9500/111-...

Recessed clamp

For: ST18



S-9500/112-...

Short pendant bracket for suspensions

For: ST1



S-9500/312-LA-...

Bracket for "in row" use junction

For: ST1



S-9500/322-LA-...

Short pendant bracket for suspensions

For: ST1



S-9500/312-SV-...

Bracket for "in row" use junction

For: ST1



S-9500/322-SV-...

Track fixing accessories



For Track: **ST1 - ST2 - ST3 - ST5 - ST6 - ST7 - ST8 - ST9 - ST10 - ST13 - ST15 - ST18**

Available colours: **W** - white RAL 9010, **W2** - white RAL 9016, **B** - black RAL 9005

Short pendant bracket for suspensions

For: ST2, ST6, ST8



S-9500/313-LA

Bracket for "in row" use junction

For: ST2, ST6, ST8



S-9500/323-LA

Short pendant bracket for suspensions

For: ST2, ST6, ST8



S-9500/313-M6

Bracket for "in row" use junction

For: ST2, ST6, ST8



S-9500/323-M6

Short pendant bracket for suspensions

For: ST2, ST6, ST8



S-9500/313-M13

Bracket for "in row" use junction

For: ST2, ST6, ST8



S-9500/323-M13

Set for ceiling mounting with cup and terminal block

For: ST2, ST6, ST7, ST9, ST15



S-9500/313-SV

Bracket for "in row" use junction

For: ST2, ST6, ST8



S-9500/323-SV

Reinforcing bracket for trimless use of jointing connector

For: ST3, ST5, ST7, ST9, ST10, ST15



S-9500/314-...

Bracket for trimless use

For: ST2



S-9500/315

Short pendant bracket for suspensions

For: ST7, ST9



S-9500/317-LA

Short pendant bracket for suspensions

For: ST7, ST9



S-9500/317-M6

Short pendant bracket for suspensions

For: ST7, ST9



S-9500/317-M13

Short pendant bracket for suspensions

For: ST7, ST9



S-9500/317-SV

Short pendant bracket for suspensions with m6 gripper



S-9000/312-M6-...

Bracket with m6 gripper for "in row" use junction



S-9000/322-M6-...

Short pendant bracket for suspensions

For: ST5



S-9500/314-LA-...

Short pendant bracket for suspensions

For: ST5



S-9500/314-M6-...

Short pendant bracket for suspensions

For: ST1



S-9500/312-SV-...

Bracket for "in row" use junction

For: ST1



S-9500/322-SV-...

Track fixing accessories

For Track: **ST1 - ST2 - ST3 - ST5 - ST6 - ST7 - ST8 - ST9 - ST10 - ST13 - ST15 - ST18**

Available colours: **W** - white RAL 9010, **W2** - white RAL 9016, **B** - black RAL 9005

Plastic cup for steel cable \varnothing 1.5 mm



S-9000/3-...

Round head ceiling attachment



S-9000/216-...

Ceiling bracket for suspensions

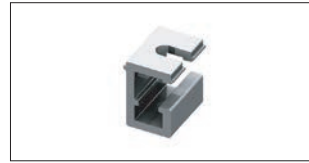

S-9000/132

Hook with fixing hole (\varnothing 13mm) for stem



S-9000/232

Steel cable



S-9000/211-1,5
S-9000/211-3
S-9000/211-5

Steel cable with spherical end



S-9000/211-S-1,5
S-9000/211-S-3
S-9000/211-S-5

Stem with m13x1 end and nut



S-9000-1,2/604-...

Automatic lock



S-9000/214

Screw gripper



S-9000/215

Automatic M5 gripper with side hole



S-9000/218

Automatic M5 gripper with side hole



S-9000/220

Set screw for gripper on the bracket



602/F

Toothed elastic washer M5a for round track



S-9000/601

For Track: **ST2 - ST3 - ST5 - ST6 - ST8 - ST9 - ST10 - ST18**
 Available colours: **W2** - white RAL 9016, **B** - black RAL 9005

Mechanical L-joint

For: ST2



S-9511/...-ST2

L Bracket for angles



S-9511/316-LA

Mechanical L-joint

For: ST2



S-9511/...-P-ST2

Mechanical T-joint

For: ST2



S-9513/...-P-ST2

Mechanical X-joint

For ST2 track

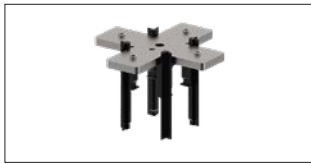

S-9517/...-P-ST2

External vertical mechanical corner joint

For: ST3

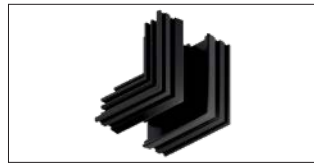

S-9511-E/...-ST3-E

Internal vertical mechanical corner joint

For: ST3

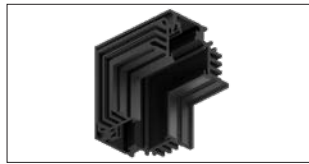

S-9511-I/...-ST3-E

Horizontal mechanical corner joint

For: ST3

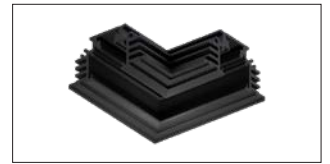

S-9511/...-ST3-E

External vertical mechanical corner joint

For: ST5

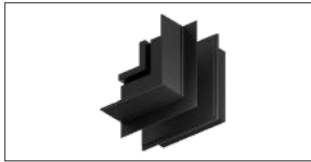

S-9511-E/...-ST5

Internal vertical mechanical corner joint

For: ST5

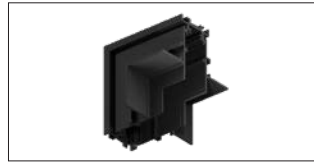

S-9511-I/...-ST5

Horizontal mechanical corner joint

For: ST5

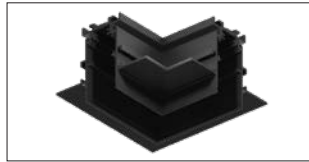

S-9511/...-ST5

Mechanical I-joint

For: ST6



S-9511/...-ST6

Mechanical L-joint

For: ST6



S-9511/...-P-ST6

Mechanical T-joint

For: ST6



S-9513/...-P-ST6

Mechanical X-joint

For: ST6

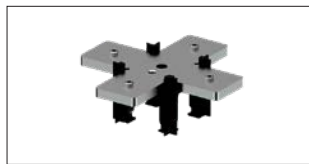

S-9517/...-P-ST6

Mechanical L-joint

For: ST8-E

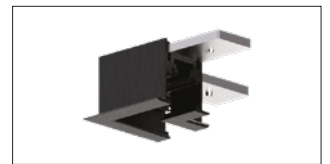

S-9511/...-ST8-E

Mechanical L-joint

For: ST9



S-9511/...-P-ST9

Mechanical T-joint

For: ST9



S-9513/...-P-ST9

Mechanical X-joint

For: ST9



S-9517/...-P-ST9

External vertical mechanical corner joint

For: ST10



S-9511-E/...-ST10

Connection joinings accessories

For Track: **ST2 - ST3 - ST5 - ST6 - ST8 - ST9 - ST10 - ST18**
Available colours: **W2** - white RAL 9016, **B** - black RAL 9005

Internal vertical mechanical
corner joint
For: ST10



S-9511-I/...-ST10

Horizontal mechanical corner
joint
For: ST10

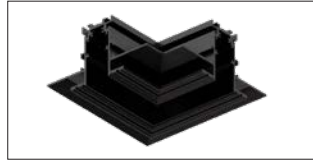

S-9511/...-ST10

Mechanical l-joint

For: ST18-E

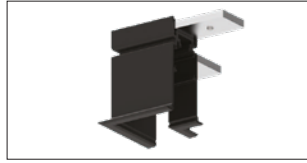

S-9511/...-P-ST2