

Date	<input type="text"/>	Type	<input type="text"/>
Specifier	<input type="text"/>	Project Name	<input type="text"/>



EMA 01

Design: QUATTROBI TECHNICAL DEPARTMENT

Led track light projector with magnetic fastening system.

Listings: US LISTED

M1001

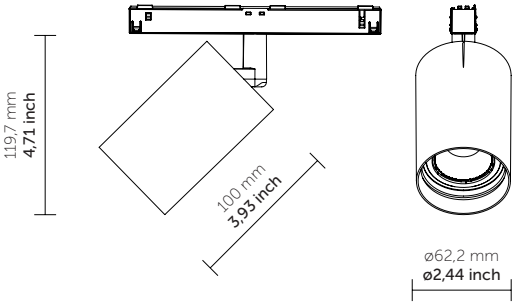

PRODUCT FEATURES

Track type - ST1, ST3, ST6, ST8

M1021

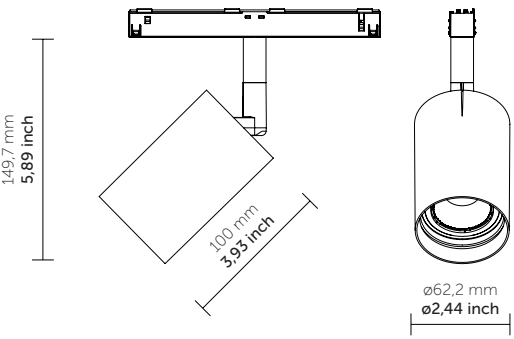

- Type: Track
- Applications: Indoor
- Luminaire material: Aluminium alloys
- Protective screen: Polycarbonate
- Light source: LED
- Power Supply: DC/DC led driver integrated
- Wattage: 20
- Delivered lumens: 1548 lm - 2367 lm
- Color Temp: 2700K, 3000K, 3500K, 4000K
- CRI: 80+, 90+, CRIMAX, F90
- Dimming: 0/1-10V dim

Track type - ST2, ST5, ST10, ST14

Specification recap

Type	Item #	Quantity

*Please make sure to include fixture and any accessories.

Ordering info

Model	Adapter	Cri/Color	Beam	Dimming	Finish
-----	-	----	-		--
M1001 20W M1021 20W M1031 20W	K Serie 9500 compatible (***)	8030 80CRI/3000K 8035 80CRI/3500K 8040 80CRI/4000K 9027 90CRI/2700K 9030 90CRI/3000K 9035 90CRI/3500K 9730 97CRI/3000K CR27 CRIMAX/2700K CR30 CRIMAX/3000K CR35 CRIMAX/3500K CR40 CRIMAX/4000K F930 F90CRI/3000K F935 F90CRI/3500K F940 F90CRI/4000K Decor Version and other on request	S Spot M Medium W Wide Other on request	1. On/off A 0-10V (°) D Dali	01 white 02 black Other on request

*For other CRI, KELVIN and other customization please contact the cunsomer service

Ordering example : **M1001 M 8030 M A 01**

(**) adapter for Multisystem Evo 9500 series installable only in class 2 circuit

(***) adapter for Multisystem Evo 9500 series, Installable in isolated Low voltage circuits and in Class2 circuit

EMA 01

Design: QUATTROBI TECHNICAL DEPARTMENT



Multiplying factors: (Multiplying Factor is based on 80CRI/3000K)

CCT	80CRI/3000K	80CRI/3500K	80CRI/4000K	90CRI/3000K
Factor	1.0	1,035	1,053	0,847

Wattage	15W	20W
Factor	1.0	1.426

Photometry

8030 S 15W 3000K CRI84 19°
Lumens: 2171

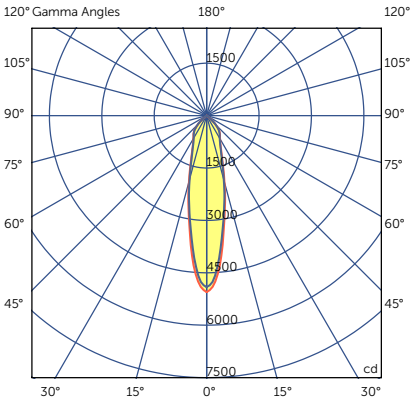

Candelas at Nadir

Deg	Candela
0	5049.32
5	4028.14
15	1799.25
25	892.52
35	642.19
45	292.84

8030 M 15W 3000K CRI84 38°
Lumens: 2171

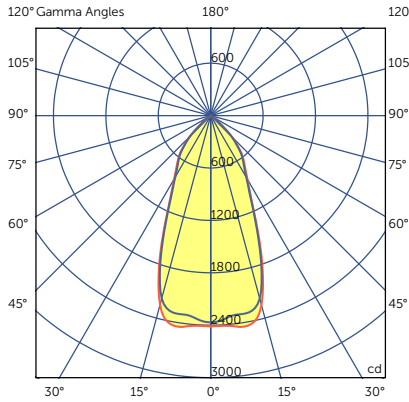

Candelas at Nadir

Deg	Candela
0	2413.03
5	2422.68
15	2149.83
25	1062.99
35	645.14
45	292.84

8030 W 15W 3000K CRI84 55°
Lumens: 2171

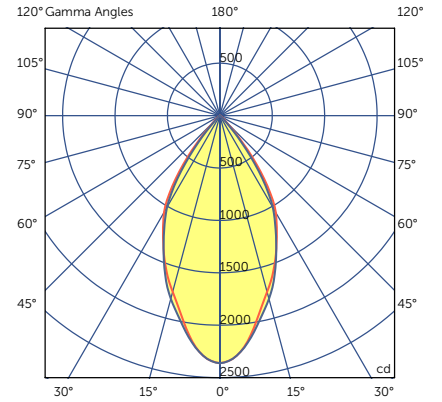

Candelas at Nadir

Deg	Candela
0	2362.05
5	2260.01
15	1740.27
25	1283.28
35	699.71
45	92.83

Date		Type	
Specifier		Project Name	



EMA TRACK

Led track light projector with magnetic fastening system.

PRODUCT FEATURES

Installation	Suspended / Surface / Recessed
Track housing	Extruded aluminum
Finishing	White, Black

Listings: US LISTED



ST1

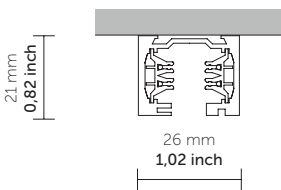

ST2

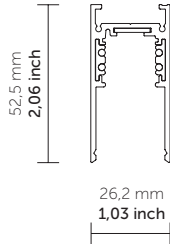

ST3

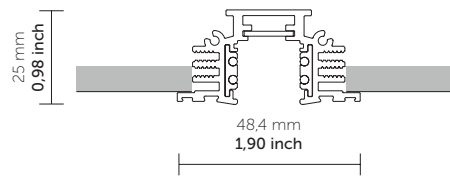

ST5

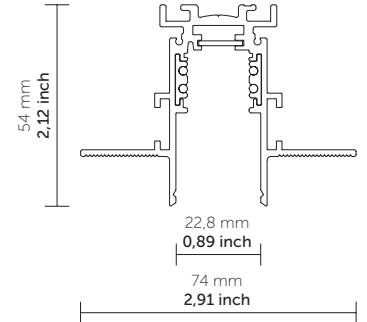

Ordering info

Model	Length	Finish	Version
-----		--	---
A9500	-1/ 39,37" (1 mt.) -2/ 78,74" (2 mt.) -3/ 118,1" (3mt.)	B black W white	-ST1 -ST3 (black color only) -ST2 -ST5 (black color only)
	-4' / 1219,2 mm -8' / 2438,4 mm in request		







(*) adapter for Track Multisystem 9500 series

*For other CRI, KELVIN and other customization please contact the cunsomer service

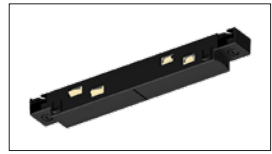
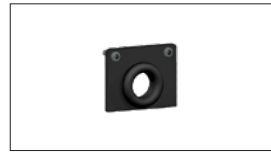
Ordering example: **A9500 B ST1**

M 080 48 12

Remote Driver, input voltage 120V 60Hz , output class2 48V DC 2Amps

Live end	Straight connector	Dead end for ST1/ST6	Dead end for ST1/ST6	Dead end for ST3
				
A9501/B A9501/W	A9503/B A9503/W	A9504/ST1-B A9504/ST1-W	A9504/ST1-B-F A9504/ST1-W-F	A9504/ST3-B A9504/ST3-W
Dead end for ST2/ST5	Dead end for ST2/ST5	Suspension for ST1/ST3	Suspension for ST1/ST3	Suspension for ST2
				
A9504/ST2-B A9504/ST2-W	A9504/ST2-B-F A9504/ST2-W-F	A519/3	A519/3/B	A619/3
Suspension for ST2	Suspension for ST5			
				
A619/3/B	A819/3/B			

Date		Type	
Specifier		Project Name	



EMA TRACK

Low voltage track
Low voltage magnetic system Serie 9500 (*)

PRODUCT FEATURES

Installation	Suspended / Surface / Recessed
Track housing	Extruded aluminum
Finishing	White, Black

Listings: US LISTED

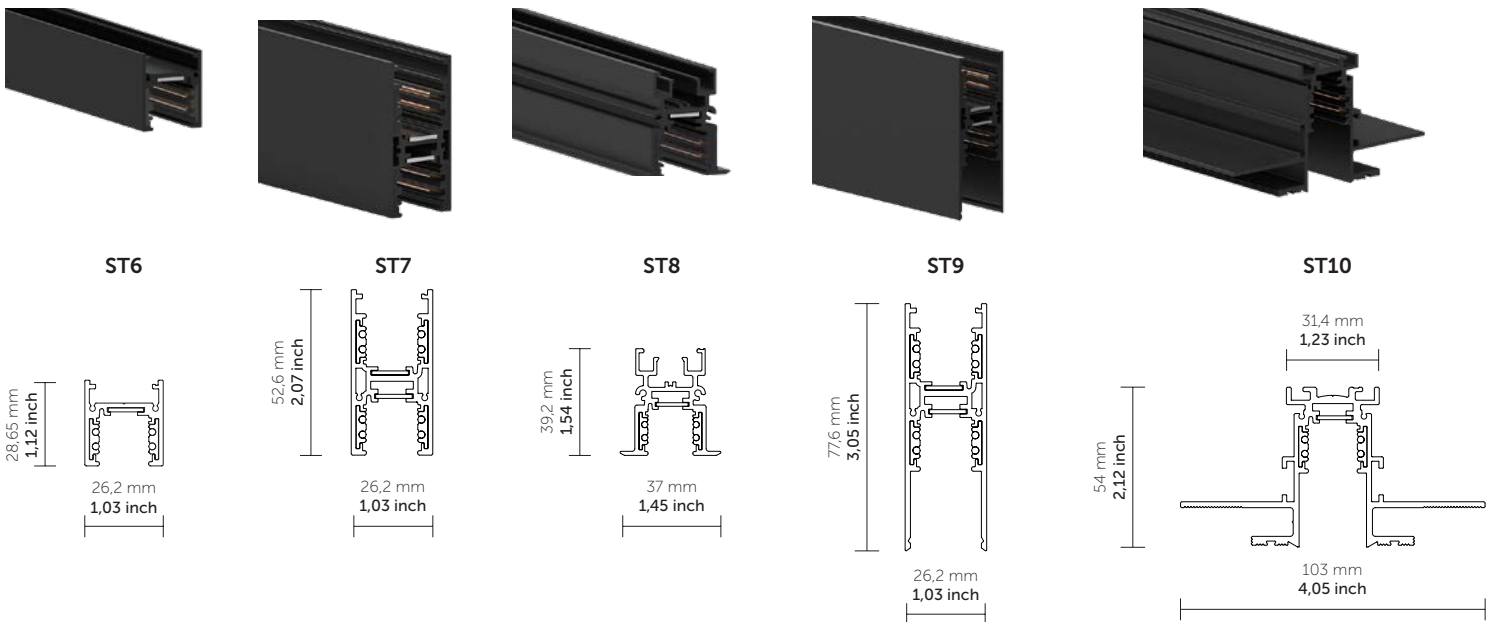

Ordering info

Model	Length	Finish	Version
----		--	---
A9500	-1/ 39,37" (1 mt.) -2/ 78,74" (2 mt.) -3/ 118,1" (3mt.)	B black W white	- ST6 - ST7 - ST8 (black color only) - ST9 (black color only) - ST10 (black color only)
	-4' / 1219,2 mm -8' / 2438,4 mm in request		



Ordering example: **A9500 B ST1**

(*) adapter for Track Multisystem 9500 series

*For other CRI, KELVIN and other customization please contact the cunsomer service

M 080 48 12

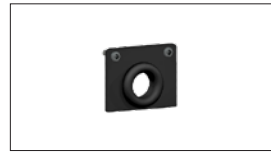
Remote Driver, input voltage 120V 60Hz , output class2 48V DC 2Amps

Live end	Straight connector	Dead end for ST1/ST6	Dead end for ST1/ST6	Dead end for ST3
				
A9501/B A9501/W	A9503/B A9503/W	A9504/ST1-B A9504/ST1-W	A9504/ST1-B-F A9504/ST1-W-F	A9504/ST3-B A9504/ST3-W
Dead end for ST2/ST5	Dead end for ST2/ST5	Suspension for ST1/ST3	Suspension for ST1/ST3	Suspension for ST2
				
A9504/ST2-B A9504/ST2-W	A9504/ST2-B-F A9504/ST2-W-F	A519/3	A519/3/B	A619/3
Suspension for ST2	Suspension for ST5			
				
A619/3/B	A819/3/B			